

UNOCODE *F100 F400 F600 F800 F900*



PER:
FOR:

ABLOY (SE)

OPTIONAL



F100
F400
F600
F800
F900

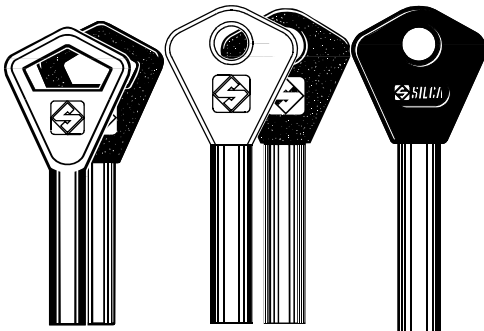

AY1 AY1P

AY2 AY2P

AY3 AY3P

AY10P

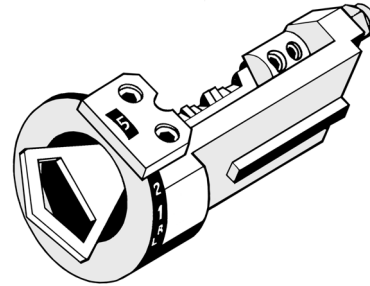

D708708ZB

B4-Code attachment for ABLOY keys
B4-Dispositivo a codice per chiavi ABLOY
B4-Code-Vorrichtung für ABLOY Schlüssel
B4-Dispositif à code pour clés ABLOY
B4-Dispositivo a código para llaves ABLOY
B4-Dispositivo por código para chaves ABLOY

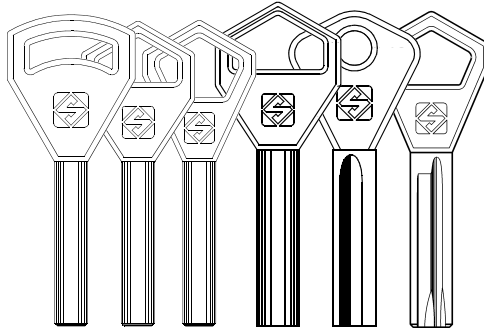

AY11 AY12 AY16 AY13 AY14 AY23

AY15

AY17

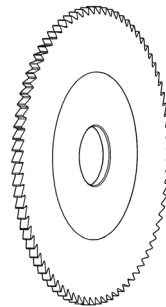

D7A3854ZB

Cutter U12W (carbide)
Fresa U12W (metallo duro)
Fräser U12W (Hartmetall)
Fraise U12W (au carbure)
Fresa U12W (metal duro)
Fresa U12W (metal duro)

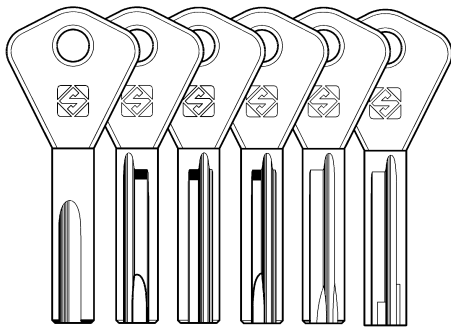

AY24 AY25 AY26 AY27 AY28 AY29



PER:
FOR:

CITROËN (FR)

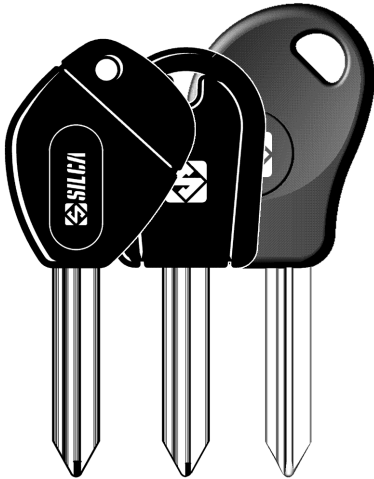

VALEO - SIMPLEX (FR)

OPTIONAL



F100
F400
F600
F800
F900

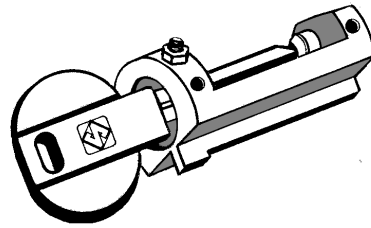

D708040ZB

B6-Code adapter for SIMPLEX
B6-Adattatore a codice per chiavi SIMPLEX
B6-Code-Adapter für SIMPLEX Schlüssel
B6-Adaptateur à code pour clés SIMPLEX
B6-Adaptador a código para llaves SIMPLEX
B6-Adaptador por código para chaves SIMPLEX

PER:
FOR:

FORD (EU+USA)

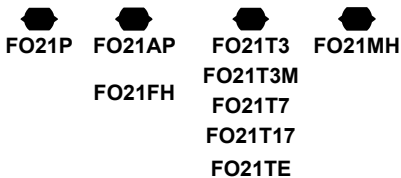
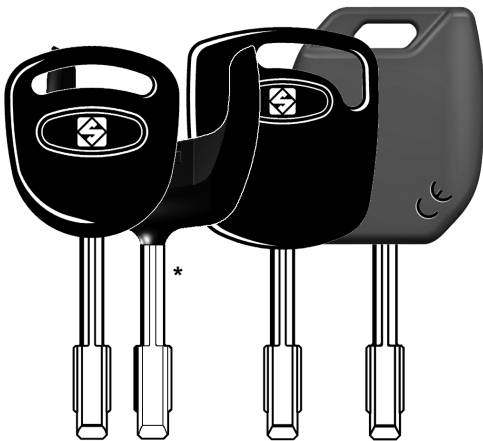

* **IMPORTANT!** Key blank to be applied to the original remote control
(the remote control includes the transponder chip)

TIBBE (DE)
VALEO (FR)

OPTIONAL



F100
F400
F600
F800
F900

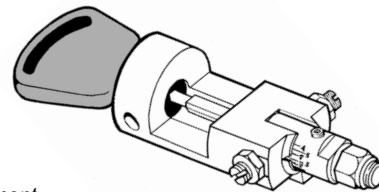

D708704ZB

B2-Code attachment
B2-Dispositivo a codice
B2-Code-Vorrichtung
B2-Dispositif à code
B2-Dispositivo a código
B2-Dispositivo por código

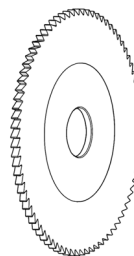

D7A3854ZB

Cutter U12W (carbide)
Fresa U12W (metallo duro)
Fräser U12W (Hartmetall)
Fraise U12W (au carbure)
Fresa U12W (metal duro)
Fresa U12W (metal duro)

UNOCODE *F100 F400 F600 F800 F900*



PER:
FOR: **PORSCHE (DE)**

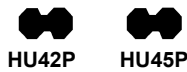
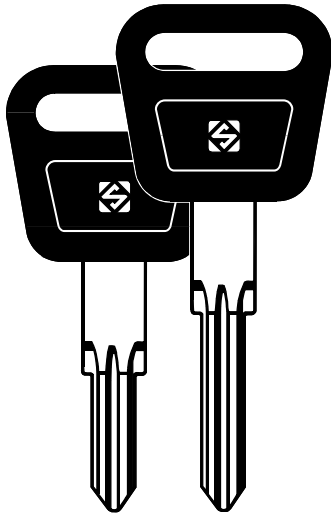

HUF (DE)

OPTIONAL



F100
F400
F600
F800
F900

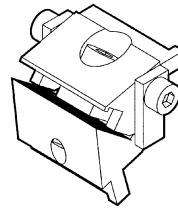

D711151ZB

*B9-Adapter for HU42P-HU45P keys
B9-Adattatori per chiavi HU42P-HU45P
B9-Adapter für HU42P-HU45P Schlüssel
B9-Adaptateur pour clés HU42P-HU45P
B9-Adaptador para llaves HU42P-HU45P
B9-Adaptador para chaves HU42P-HU45P*

PER:
FOR: **RENAULT (FR)**

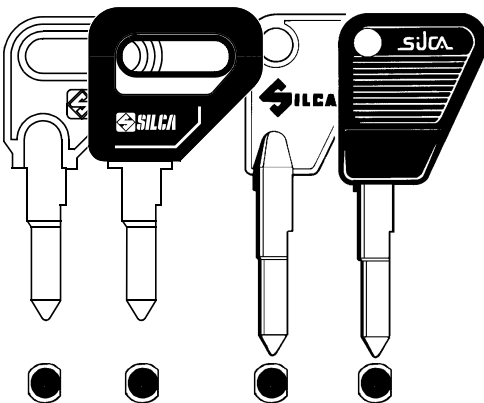

NE33S NE33SP VAC64S VAC64SP

VALEO - NEIMAN (FR)

VACHETTE (FR)

OPTIONAL



F100
F400
F600
F800
F900

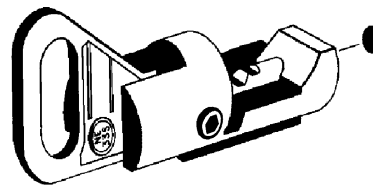

D706019ZB

*B1-Adapter for NE33S-VAC64S keys
B1-Adattatore per chiavi NE33S-VAC64S
B1-Adapter für NE33S-VAC64S Schlüssel
B1-Adaptateur pour clés NE33S-VAC64S
B1-Adaptador para llaves NE33S-VAC64S
B1-Adaptador para chaves NE33S-VAC64S*

PER:
FOR: **ZEISS-IKON (DE)**

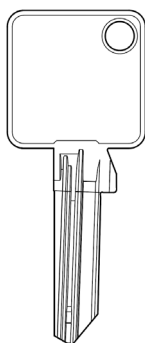

(VRS System)
(Mirrored VRS System)

OPTIONAL



F100
F400
F600
F800
F900

VRS System

D7A4369ZB

*B17 adapter
Adattatore B17
Adapter B17
Adaptateur B17
Adaptador B17
Adaptador B17*

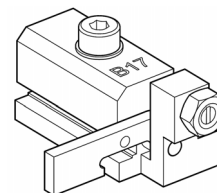

Mirrored VRS System

D7A7332ZB

*B18 adapter
Adattatore B18
Adapter B18
Adaptateur B18
Adaptador B18
Adaptador B18*

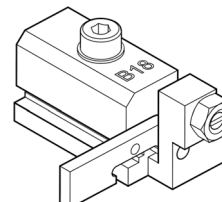

OPTIONAL
for:
F100
F400
F600

"V3" CLAMP
to be used with interchangeable jaws

D7A3836ZB
V3 clamp
Morsetto V3
V3 Spannbacke
Etau V3
Mordaza V3
Mordente V3

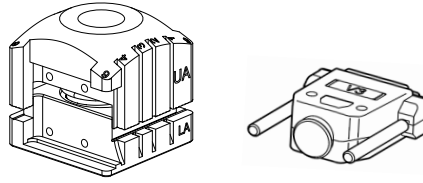

OPTIONAL

D9A3383ZR
B jaws >2,5
Ganasce B >2,5
Backen B >2,5
Mâchoires B >2,5
Quijadas B >2,5
Garras B >2,5

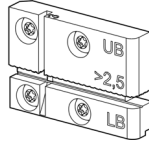

D9A3386ZR
B jaws <2,7
Ganasce B <2,7
Backen B <2,7
Mâchoires B <2,7
Quijadas B <2,7
Garras B <2,7

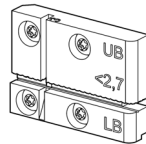

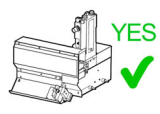
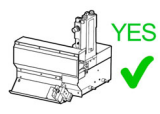
JAWS	for CLAMP	Unocode F machines	Automatic Feeder
UB-LB >2,5 UB-LB <2,7	V3	Optional for F100-F400-F600	 YES ✓
	V3 + BM	Optional for F800-F900	
UB-LB <2,7	V4	Optional for F400-F600	 YES ✓
		Standard for F800-F900	

OPTIONAL
for:
F800
F900

"V3" CLAMP + "BM" CLAMP HOLDER
to be used with interchangeable jaws

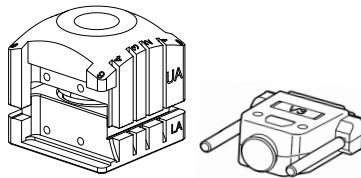

D7A3836ZB
V3 clamp
Morsetto V3
V3 Spannbacke
Etau V3
Mordaza V3
Mordente V3



D9A4338ZR
BM Clamp holder
Supporto morsetto BM
Spannbackenhalterung BM
Support ètau BM
Soporte mordaza BM
Suporte mordente BM

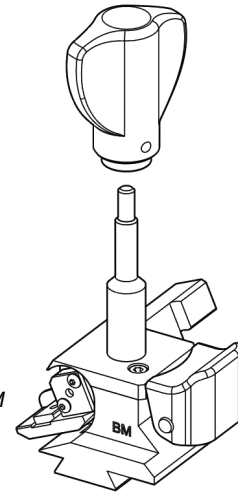

OPTIONAL
only for:
F400
F600

STANDARD
for:
F800
F900

"V4+BE" ELECTRIC CLAMP
to be used with interchangeable jaws

D9A4014ZR
V4+BE electric clamp
Morsetto elettrico V4+BE
V4+BE Elektrische Spannbacke
Etau électrique V4+BE
Mordaza eléctrica V4+BE
Mordente eléctrico V4+BE

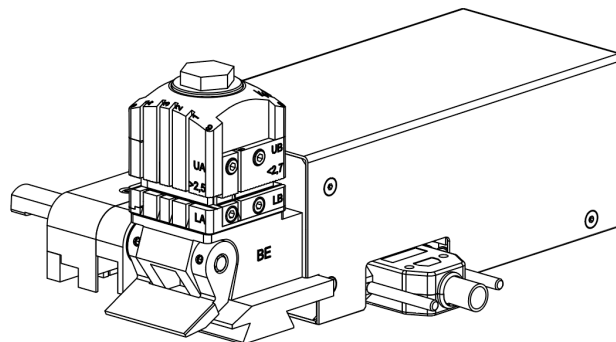

UNOCODE *F100 F400 F600 F800 F900*



PER:
FOR:

ABUS (DE)

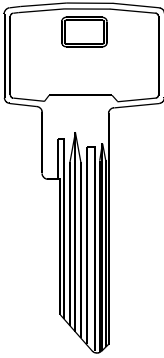

(V14 - XY14 - Y14 - Y14 Deltus - XV14 Systems)
(Vitess 1000 - 2000 - 4000 Systems)

PFAFFENHAIN

OPTIONAL



D7A3997ZB

Jaws set U6-L6
Set ganasce U6-L6
Satz Backen U6-L6
Ens.mâchoires U6-L6
Juego quijadas U6-L6
Conjunto de garras U6-L6

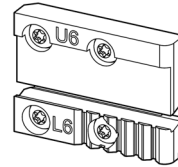

JAW	for CLAMP	Unocode F machines	Automatic Feeder + D7A6014ZB
U6-L6	V3	Optional for F100-F400-F600	YES
	V3 + BM	Optional for F800-F900	
	V4	Optional for F400-F600 Standard for F800-F900	



OPTIONAL

only for:
KEY FEEDER

D7A6014ZB

Plate
Piastrina
Plattchen
Plaqueette
Placa
Placa

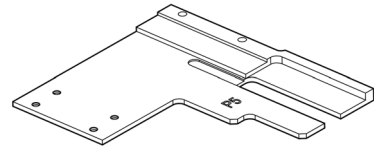

PER:
FOR:

ASSA (SE)

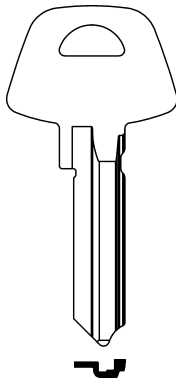

(D-12 System)

ABLOY

OPTIONAL



D7A3824ZB

Jaws set U3-L3
Set ganasce U3-L3
Satz Backen U3-L3
Ens.mâchoires U3-L3
Juego quijadas U3-L3
Conjunto de garras U3-L3

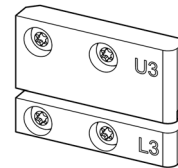

JAW	for CLAMP	Unocode F machines	Automatic Feeder
U3-L3	V3	Optional for F100-F400-F600	YES
	V3 + BM	Optional for F800-F900	
	V4	Optional for F400-F600 Standard for F800-F900	

PER:
FOR:

ASSA (SE)

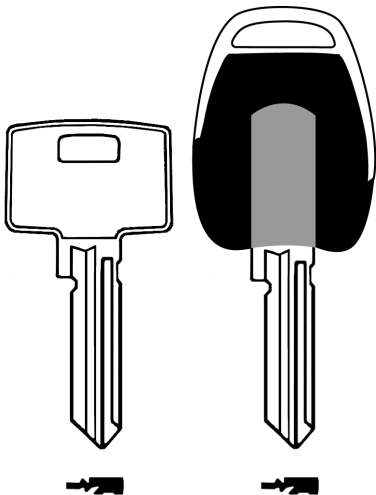

(DP System)

(CLIQ System)

OPTIONAL



D7A3826ZB

Jaws set U4-L4
Set ganasce U4-L4
Satz Backen U4-L4
Ens.mâchoires U4-L4
Juego quijadas U4-L4
Conjunto de garras U4-L4

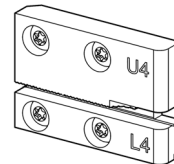

JAW	for CLAMP	Unocode F machines	Automatic Feeder
U4-L4	V3	Optional for F100-F400-F600	YES
	V3 + BM	Optional for F800-F900	
	V4	Optional for F400-F600 Standard for F800-F900	



PER:
FOR:

BKS (DE)

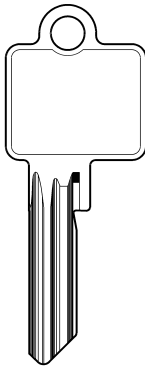

(serie 37)

OPTIONAL



D7A4191ZB

Jaws set U14-L14
Set ganasce U14-L14
Satz Backen U14-L14
Ens.mâchoires U14-L14
Juego quijadas U14-L14
Conjunto de garras U14-L14

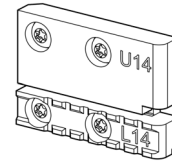

JAW	for CLAMP	Unocode F machines	Automatic Feeder
U14-L14	V3	Optional for F100-F400-F600	YES ✓
	V3 + BM	Optional for F800-F900	
	V4	Optional for F400-F600 Standard for F800-F900	

PER:
FOR:

CES (DE)

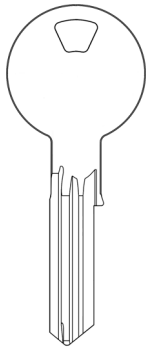

(PSM - UDM Systems)

OPTIONAL



D7A5041ZB

Jaws set U20-L20
Set ganasce U20-L20
Satz Backen U20-L20
Ens.mâchoires U20-L20
Juego quijadas U20-L20
Conjunto de garras U20-L20

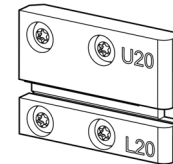

JAW	for CLAMP	Unocode F machines	Automatic Feeder
U20-L20	V3	Optional for F100-F400-F600	YES ✓
	V3 + BM	Optional for F800-F900	
	V4	Optional for F400-F600 Standard for F800-F900	

System protected by a password issued by Silca on receipt of authorization.
Sistema protetto da password rilasciata da Silca a fronte di autorizzazione.
Passwort geschütztes System - Freigabe des Herstellers erforderlich.
Système protégé par un password qui est émis par Silca sur autorisation.
Sistema protegido con contraseña que manda Silca previa autorización.
Sistema protegido por uma password emitida por Silca contra a autorização.

PER:
FOR:

CISA (IT)

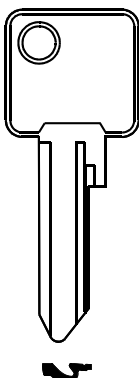

(SP-TSP Left System)

OPTIONAL



D7A3787ZB

Jaws set U1-L1
Set ganasce U1-L1
Satz Backen U1-L1
Ens.mâchoires U1-L1
Juego quijadas U1-L1
Conjunto de garras U1-L1

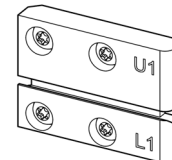

JAW	for CLAMP	Unocode F machines	Automatic Feeder
U1-L1	V3	Optional for F100-F400-F600	NO ✗
	V3 + BM	Optional for F800-F900	
	V4	Optional for F400-F600 Standard for F800-F900	

Codes tables protected by a password issued by Silca on receipt of the manufacturer's authorization.
Tabelle codici protette da password rilasciata da Silca a fronte di autorizzazione del costruttore.
Code-Tabellen geschützt durch von Silca geliefertes Passwort auf Herstellersgenehmigung.
Tables de codes protégées par un password qui est émis par Silca sur autorisation du Constructeur.
Tablas códigos protegidos con contraseña que manda Silca previa autorización.
Tabelas de códigos protegidas por uma password emitida por Silca contra autorização do fabricante.

PER:
FOR:

CISA (IT)

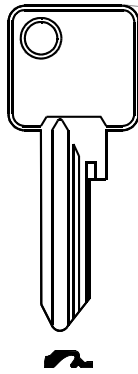

(SP-TSP Right System)

OPTIONAL



D7A3835ZB

Jaws set U2-L2
Set ganasce U2-L2
Satz Backen U2-L2
Ens.machoiros U2-L2
Juego quijadas U2-L2
Conjunto de garras U2-L2

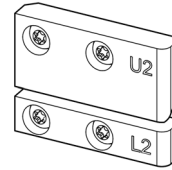

JAW	for CLAMP	Unocode F machines	Automatic Feeder
U2-L2	V3	Optional for F100-F400-F600	NO
	V3 + BM	Optional for F800-F900	
	V4	Optional for F400-F600 Standard for F800-F900	

Codes tables protected by a password issued by Silca on receipt of the manufacturer's authorization.
Tabelle codici protette da password rilasciata da Silca a fronte di autorizzazione del costruttore.
Code-Tabellen geschützt durch von Silca geliefertes Passwort auf Herstellersgenehmigung.
Tables de codes protégées par un password qui est émis par Silca sur autorisation du Constructeur.
Tablas codigos protegidos con contraseña que manda Silca previa autorización.
Tabelas de códigos protegidas por uma password emitida por Silca contra autorização do fabricante.

PER:
FOR:

CISA (IT)

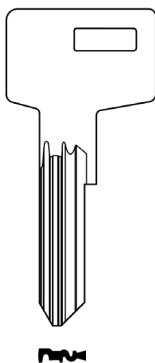

(C3000 System)
(profiles T05 - T06 - T28 - T29)

OPTIONAL



D7A5048ZB

Jaws set U21-L21
Set ganasce U21-L21
Satz Backen U21-L21
Ens.mâchoiros U21-L21
Juego quijadas U21-L21
Conjunto de garras U21-L21

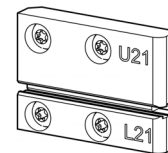

JAW	for CLAMP	Unocode F machines
U21-L21	V3	Optional for F100-F400-F600
	V3 + BM	Optional for F800-F900
	V4	Optional for F400-F600 Standard for F800-F900

Codes tables protected by a password issued by Silca on receipt of the manufacturer's authorization.
Tabelle codici protette da password rilasciata da Silca a fronte di autorizzazione del costruttore.
Code-Tabellen geschützt durch von Silca geliefertes Passwort auf Herstellersgenehmigung.
Tables de codes protégées par un password qui est émis par Silca sur autorisation du Constructeur.
Tablas codigos protegidos con contraseña que manda Silca previa autorización.
Tabelas de códigos protegidas por uma password emitida por Silca contra autorização do fabricante.

PER:
FOR:

CISA (IT)

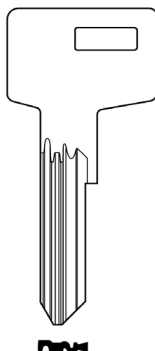

(C3000 System)
(profiles T11 - T12 - T32 - T33)

OPTIONAL



D7A5127ZB

Jaws set U22-L22
Set ganasce U22-L22
Satz Backen U22-L22
Ens.mâchoiros U22-L22
Juego quijadas U22-L22
Conjunto de garras U22-L22

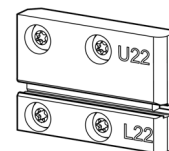

JAW	for CLAMP	Unocode F machines
U22-L22	V3	Optional for F100-F400-F600
	V3 + BM	Optional for F800-F900
	V4	Optional for F400-F600 Standard for F800-F900

Codes tables protected by a password issued by Silca on receipt of the manufacturer's authorization.
Tabelle codici protette da password rilasciata da Silca a fronte di autorizzazione del costruttore.
Code-Tabellen geschützt durch von Silca geliefertes Passwort auf Herstellersgenehmigung.
Tables de codes protégées par un password qui est émis par Silca sur autorisation du Constructeur.
Tablas codigos protegidos con contraseña que manda Silca previa autorización.
Tabelas de códigos protegidas por uma password emitida por Silca contra autorização do fabricante.

PER:
FOR:

CISA (IT)

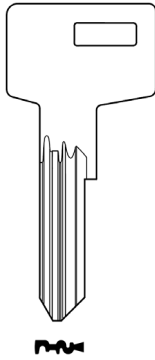

(C3000 System)
(profiles T08 - T10 - T30)

OPTIONAL



D7A5133ZB

Jaws set U23-L23
Set ganasce U23-L23
Satz Backen U23-L23
Ens.mâchoires U23-L23
Juego quijadas U23-L23
Conjunto de garras U23-L23

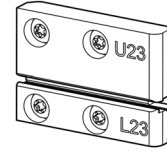

JAW	for CLAMP	Unocode F machines
U23-L23	V3	Optional for F100-F400-F600
	V3 + BM	Optional for F800-F900
	V4	Optional for F400-F600
		Standard for F800-F900

Codes tables protected by a password issued by Silca on receipt of the manufacturer's authorization.
Tabella codici protette da password rilasciata da Silca a fronte di autorizzazione del costruttore.
Code-Tabellen geschützt durch von Silca geliefertes Passwort auf Herstellersgenehmigung.
Tables de codes protégées par un password qui est émis par Silca sur autorisation du Constructeur.
Tablas codigos protegidos con contraseña que manda Silca previa autorización.
Tabelas de códigos protegidas por uma password emitida por Silca contra autorização do fabricante.

PER:
FOR:

CISA (IT)

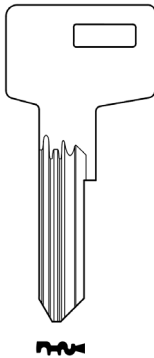

(C3000 System)
(profiles T14 - T34)

OPTIONAL



D7A5140ZB

Jaws set U24-L24
Set ganasce U24-L24
Satz Backen U24-L24
Ens.mâchoires U24-L24
Juego quijadas U24-L24
Conjunto de garras U24-L24

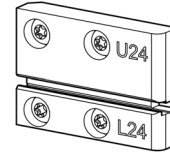

JAW	for CLAMP	Unocode F machines
U24-L24	V3	Optional for F100-F400-F600
	V3 + BM	Optional for F800-F900
	V4	Optional for F400-F600
		Standard for F800-F900

Codes tables protected by a password issued by Silca on receipt of the manufacturer's authorization.
Tabella codici protette da password rilasciata da Silca a fronte di autorizzazione del costruttore.
Code-Tabellen geschützt durch von Silca geliefertes Passwort auf Herstellersgenehmigung.
Tables de codes protégées par un password qui est émis par Silca sur autorisation du Constructeur.
Tablas codigos protegidos con contraseña que manda Silca previa autorización.
Tabelas de códigos protegidas por uma password emitida por Silca contra autorização do fabricante.

PER:
FOR:

DOM (DE)

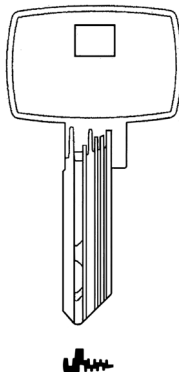

(RS8 System)

OPTIONAL



D7A3830ZB

Jaws set U5-L5
Set ganasce U5-L5
Satz Backen U5-L5
Ens.mâchoires U5-L5
Juego quijadas U5-L5
Conjunto de garras U5-L5

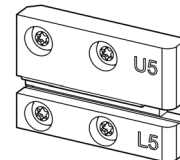

JAW	for CLAMP	Unocode F machines	Automatic Feeder
U5-L5	V3	Optional for F100-F400-F600	YES ✓
	V3 + BM	Optional for F800-F900	
	V4	Optional for F400-F600	
		Standard for F800-F900	

PER:
FOR:

EVVA (AT)

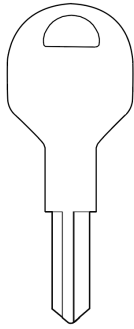

(DUAL-E System)



OPTIONAL

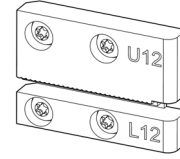

D7A4159ZB

Jaws set U12-L12
Set ganasce U12-L12
Satz Backen U12-L12
Ens.mâchoires U12-L12
Juego quijadas U12-L12
Conjunto de garras U12-L12

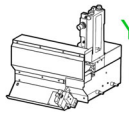

JAW	for CLAMP	Unocode F machines	Automatic Feeder
U12-L12	V3	Optional for F100-F400-F600	 YES 
	V3 + BM	Optional for F800-F900	
	V4	Optional for F400-F600 Standard for F800-F900	

PER:
FOR:

FAB (CZ)

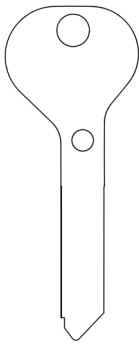

(FAB200RS System)



OPTIONAL

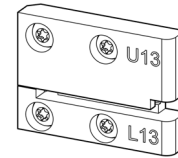

D7A4166ZB

Jaws set U13-L13
Set ganasce U13-L13
Satz Backen U13-L13
Ens.mâchoires U13-L13
Juego quijadas U13-L13
Conjunto de garras U13-L13

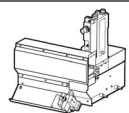

JAW	for CLAMP	Unocode F machines	Automatic Feeder
U13-L13	V3	Optional for F100-F400-F600	 NO 
	V3 + BM	Optional for F800-F900	
	V4	Optional for F400-F600 Standard for F800-F900	

PER:
FOR:

GEGE (AT)

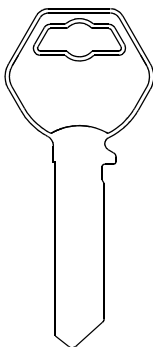

(AP3000 System)

OPTIONAL





CARD 826
SN 2878

CARD 827
SN 2879

D7A4076ZB

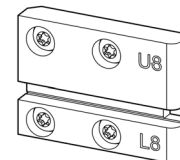
Jaws set U8-L8
Set ganasce U8-L8
Satz Backen U8-L8
Ens.mâchoires U8-L8
Juego quijadas U8-L8
Conjunto de garras U8-L8

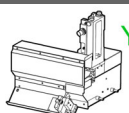

JAW	for CLAMP	Unocode F machines	Automatic Feeder
U8-L8	V3	Optional for F100-F400-F600	 YES 
	V3 + BM	Optional for F800-F900	
	V4	Optional for F400-F600 Standard for F800-F900	

PER:
FOR:

LOCKWOOD (AUS)

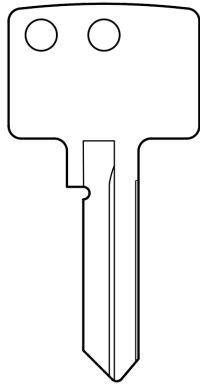

(Twin T35 System)

OPTIONAL



D7A6324ZB

Jaws set U26-L26
Set ganasce U26-L26
Satz Backen U26-L26
Ens. mâchoires U26-L26
Juego quijadas U26-L26
Conjunto de garras U26-L26

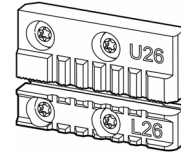

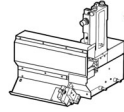
JAW	for CLAMP	Unocode F machines	Automatic Feeder
U26-L26	V3	Optional for F100-F400-F600	 YES ✓
	V3 + BM	Optional for F800-F900	
	V4	Optional for F400-F600 Standard for F800-F900	

PER:
FOR:

MLAA (AUS)

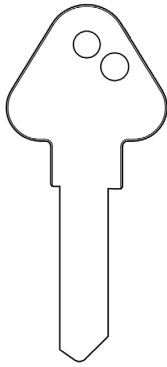

(DC1 System)

OPTIONAL



D7A5382ZB

Jaws set U25-L25
Set ganasce U25-L25
Satz Backen U25-L25
Ens. mâchoires U25-L25
Juego quijadas U25-L25
Conjunto de garras U25-L25

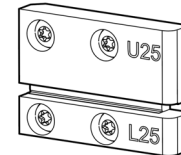

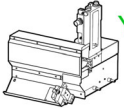
JAW	for CLAMP	Unocode F machines	Automatic Feeder
U25-L25	V3	Optional for F100-F400-F600	 YES ✓
	V3 + BM	Optional for F800-F900	
	V4	Optional for F400-F600 Standard for F800-F900	

PER:
FOR:

WILKA (DE)

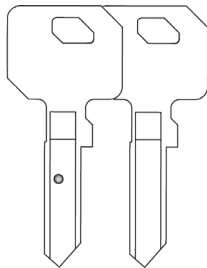

(Carat S1 - Carat S4 Systems)

STANDARD CUTS

SYSTEM	CARD	SN
Carat S1	4357	4838
Carat S4	4357	4839

OPTIONAL



D7A5034ZB

Jaws set U19-L19
Set ganasce U19-L19
Satz Backen U19-L19
Ens. mâchoires U19-L19
Juego quijadas U19-L19
Conjunto de garras U19-L19

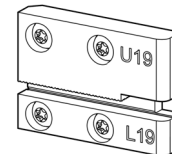

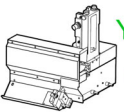
JAW	for CLAMP	Unocode F machines	Automatic Feeder
U19-L19	V3	Optional for F100-F400-F600	 YES ✓
	V3 + BM	Optional for F800-F900	
	V4	Optional for F400-F600 Standard for F800-F900	

PER:
FOR:

WINKHAUS (DE)

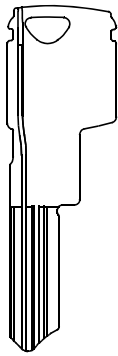

(RPE - RPS Systems)

OPTIONAL



D7A4000ZB

Jaws set U7-L7
Set ganasce U7-L7
Satz Backen U7-L7
Ens.mâchoires U7-L7
Juego quijadas U7-L7
Conjunto de garras U7-L7

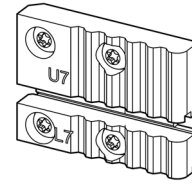

JAW	for CLAMP	Unocode F machines	Automatic Feeder
U7-L7	V3	Optional for F100-F400-F600	YES ✓
	V3 + BM	Optional for F800-F900	
	V4	Optional for F400-F600 Standard for F800-F900	

System protected by a password issued by Silca on receipt of authorization.
Sistema protetto da password rilasciata da Silca a fronte di autorizzazione.
Passwort geschütztes System - Freigabe des Herstellers erforderlich.
Système protégé par un password qui est émis par Silca sur autorisation.
Sistema protegido con contraseña que manda Silca previa autorización.
Sistema protegido por uma password emitida por Silca contra a autorização.

PER:
FOR:

ZEISS-IKON (DE)

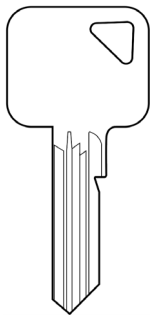

(ASP 34, 27 Systems)

OPTIONAL



D7A6769ZB

Jaws set U16-L16
Set ganasce U16-L16
Satz Backen U16-L16
Ens.mâchoires U16-L16
Juego quijadas U16-L16
Conjunto de garras U16-L16

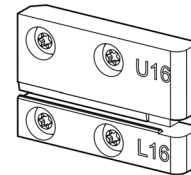

JAW	for CLAMP	Unocode F machines	Automatic Feeder
U16-L16	V3	Optional for F100-F400-F600	YES ✓
	V3 + BM	Optional for F800-F900	
	V4	Optional for F400-F600 Standard for F800-F900	

PER:
FOR:

KEYS WITH DOUBLE ASYMMETRICAL STOP

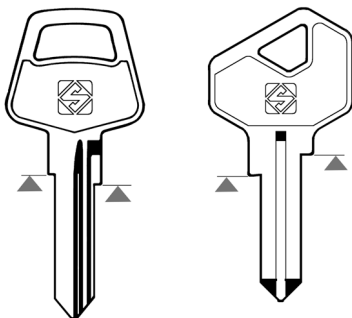

LF2 - LF16R - LF26 - LF43R

Example of popular references

OPTIONAL



D7A6866ZB

Jaws set U27-L27
Set ganasce U27-L27
Satz Backen U27-L27
Ens.mâchoires U27-L27
Juego quijadas U27-L27
Conjunto de garras U27-L27

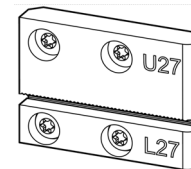

JAW	for CLAMP	Unocode F machines	Automatic Feeder
U27-L27	V3	Optional for F100-F400-F600	NO ✗
	V3 + BM	Optional for F800-F900	
	V4	Optional for F400-F600 Standard for F800-F900	

OPTIONAL

F100
F400
F600
F800
F900

"V1F" ROTATING CLAMP

D722893ZB

V1F rotating clamp
Morsetto girevole V1F
V1F Spannbacke
Etau pivotant V1F
Mordaza giratoria V1F
Mordente giratorio V1F

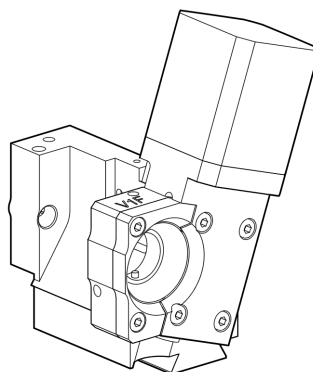

OPTIONAL

F100
F400
F600
F800
F900

"V1" Kit Upgrade

D7A3844ZB V1 kit upgrade



Upgrade of V1 clamp to V1F version for Unocode F machines. For information please contact Silca's Technical Service Department.

Aggiornamento del morsetto V1 alla versione V1F per le duplicatrici Unocode F. Per informazioni contattare il Servizio Assistenza Tecnica Silca.

Upgrade der V1-Spannbacke auf V1F-Version für Unocode F Schlüsselkopiermaschinen. Für weitere Informationen den Silca-Kundendienst kontaktieren.

Mise à jour de l'étau V1 à la version V1F pour les machines Unocode F. Pour informations, contacter notre Service d'Assistance Silca.

Actualización de la mordaza V1 a la versión V1F para las duplicadoras Unocode F. Para informaciones, contactar el Servicio de Asistencia Técnica de Silca.

Atualização do mordente V1 na versão V1F para as máquinas Unocode F. Para informações contacte o Serviço de Assistência Silca.

Kit tools for V1F rotating clamp

PER:
FOR:

ABLOY (SE)

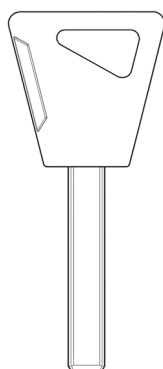

(Disklock System)

OPTIONAL

◆ CODE

D737531ZB

G21-Kit tools for ABLOY keys
G21-Set contropunta per chiavi ABLOY
G21-Werkzeuge für ABLOY Schlüssel
G21-Outils pour clés ABLOY
G21-Útiles para llaves ABLOY
G21-Contraponta para chaves ABLOY

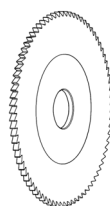
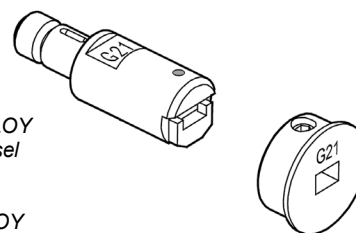

D7A3856ZB

Cutter U13W (carbide)
Fresa U13W (metallo duro)
Fräser U13W (Hartmetall)
Fraise U13W (au carbure)
Fresa U13W (metal duro)
Fresa U13W (metal duro)

PER:
FOR:

ABLOY (SE)

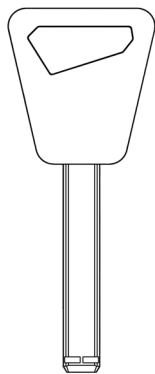

(Novel System)

OPTIONAL



D737531ZB

G21-Kit tools for ABLOY keys
G21-Set contropunta per chiavi ABLOY
G21-Werkzeuge für ABLOY Schlüssel
G21-Outils pour clés ABLOY
G21-Útiles para llaves ABLOY
G21-Contraponta para chaves ABLOY

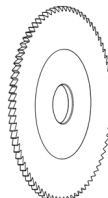
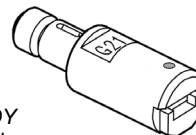

D7A3856ZB

Cutter U13W (carbide)
Fresa U13W (metallo duro)
Fräser U13W (Hartmetall)
Fraise U13W (au carbure)
Fresa U13W (metal duro)
Fresa U13W (metal duro)

System protected by a password issued by Silca on receipt of authorization.
Sistema protetto da password rilasciata da Silca a fronte di autorizzazione.
Passwort geschütztes System - Freigabe des Herstellers erforderlich.
Système protégé par un password qui est émis par Silca sur autorisation.
Sistema protegido con contraseña que manda Silca previa autorización.
Sistema protegido por uma password emitida por Silca contra a autorização.

PER:
FOR:

ABLOY (SE)

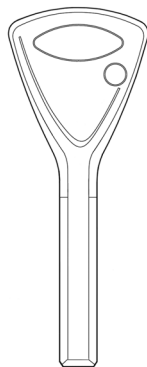

(Protec - Protec 2 Systems)

OPTIONAL



D737536ZB

G22-Kit tools for ABLOY keys
G22-Set contropunta per chiavi ABLOY
G22-Werkzeuge für ABLOY Schlüssel
G22-Outils pour clés ABLOY
G22-Útiles para llaves ABLOY
G22-Contraponta para chaves ABLOY

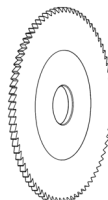
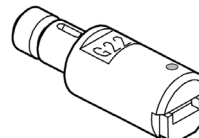

D7A3856ZB

Cutter U13W (carbide)
Fresa U13W (metallo duro)
Fräser U13W (Hartmetall)
Fraise U13W (au carbure)
Fresa U13W (metal duro)
Fresa U13W (metal duro)

System protected by a password issued by Silca on receipt of authorization.
Sistema protetto da password rilasciata da Silca a fronte di autorizzazione.
Passwort geschütztes System - Freigabe des Herstellers erforderlich.
Système protégé par un password qui est émis par Silca sur autorisation.
Sistema protegido con contraseña que manda Silca previa autorización.
Sistema protegido por uma password emitida por Silca contra a autorização.

PER:
FOR:

ABLOY (SE)

OPTIONAL

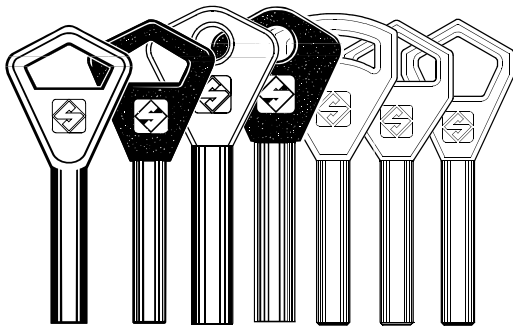

AY1 AY1P AY2 AY2P AY11 AY12 AY16

AY3 AY3P

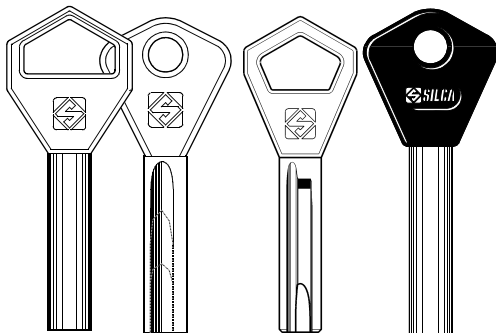

AY13 AY14 AY15 AY17
AY18 AY20 AY21 AY23 AY10P

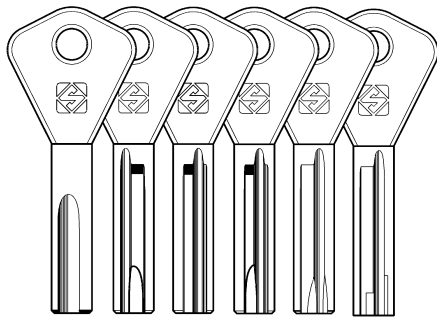

AY24 AY25 AY26 AY27 AY28 AY29

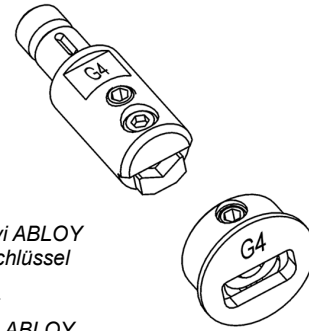

D723053ZB

G4-Kit tools for ABLOY keys
G4-Set contropunta per chiavi ABLOY
G4-Werkzeuge für ABLOY Schlüssel
G4-Outils pour clés ABLOY
G4-Útiles para llaves ABLOY
G4-Contraponta para chaves ABLOY

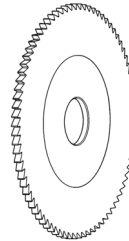

D7A3854ZB

Cutter U12W (carbide)
Fresa U12W (metallo duro)
Fräser U12W (Hartmetall)
Fraise U12W (au carbure)
Fresa U12W (metal duro)
Fresa U12W (metal duro)

PER:
FOR:

ABUS (DE)

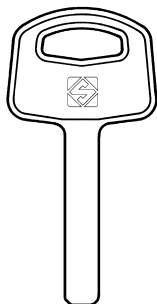

■
AB32

OPTIONAL



D723055ZB

G12-Kit tools for AB32 keys
G12-Set contropunta per chiavi AB32
G12-Werkzeuge für AB32 Schlüssel
G12-Outils pour clés AB32
G12-Útiles para llaves AB32
G12-Contraponta para chaves AB32

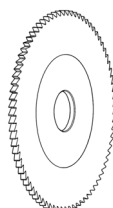
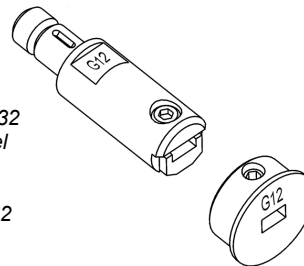

D7A3854ZB

Cutter U12W (carbide)
Fresa U12W (metallo duro)
Fräser U12W (Hartmetall)
Fraise U12W (au carbure)
Fresa U12W (metal duro)
Fresa U12W (metal duro)

PER:
FOR:

ABUS (DE)



■
AB38P

■
AB60P

OPTIONAL



D723057ZB

G13/G19-Kit tools for AB38P-AB60P keys
G13/G19-Set contropunta per chiavi AB38P-AB60P
G13/G19-Werkzeuge für AB38P-AB60P Schlüssel
G13/G19-Outils pour clés AB38P-AB60P
G13/G19-Útiles para llaves AB38P-AB60P
G13/G19-Contraponta para chaves AB38P-AB60P

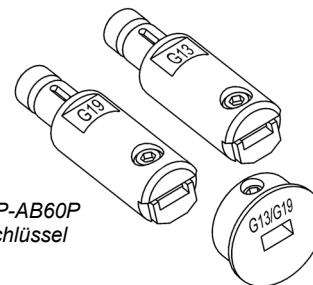

AB38P

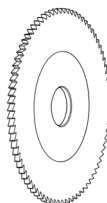

D7A3854ZB

Cutter U12W (carbide)
Fresa U12W (metallo duro)
Fräser U12W (Hartmetall)
Fraise U12W (au carbure)
Fresa U12W (metal duro)
Fresa U12W (metal duro)

AB60P

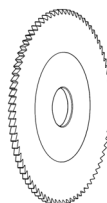

D7A3856ZB

Cutter U13W (carbide)
Fresa U13W (metallo duro)
Fräser U13W (Hartmetall)
Fraise U13W (au carbure)
Fresa U13W (metal duro)
Fresa U13W (metal duro)

PER:
FOR:

ANCHOR LÅS (SE)

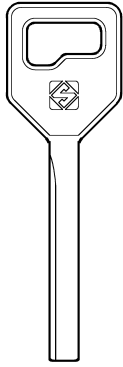

ACR3

OPTIONAL



D723049ZB

G11-Kit tools for ANCHOR-LÅS keys
G11-Set contropunta per chiavi ANCHOR-LÅS
G11-Werkzeuge für ANCHOR-LÅS Schlüssell
G11-Outils pour clés ANCHOR-LÅS
G11-Útiles para llaves ANCHOR-LÅS
G11-Contraponta para chaves ANCHOR-LÅS

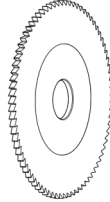
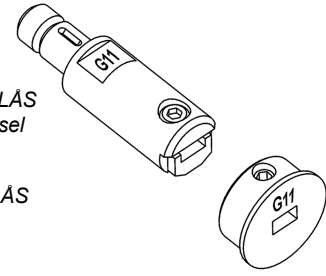

D7A3854ZB

Cutter U12W (carbide)
Fresa U12W (metallo duro)
Fräser U12W (Hartmetall)
Fraise U12W (au carbure)
Fresa U12W (metal duro)
Fresa U12W (metal duro)

PER:
FOR:

CHUBB (GB)

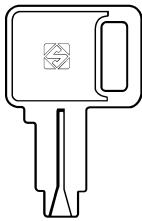

CHU5

OPTIONAL



D723160ZB

G15-Kit tools for CHU5 keys
G15-Set contropunta per chiavi CHU5
G15-Werkzeuge für CHU5 Schlüssell
G15-Outils pour clés CHU5
G15-Útiles para llaves CHU5
G15-Contraponta para chaves CHU5

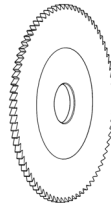
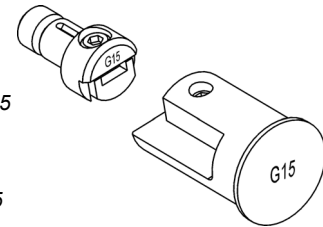

D7A3853ZB

Cutter U11W (carbide)
Fresa U11W (metallo duro)
Fräser U11W (Hartmetall)
Fraise U11W (au carbure)
Fresa U11W (metal duro)
Fresa U11W (metal duro)

PER:
FOR:

FORD (EU+USA)

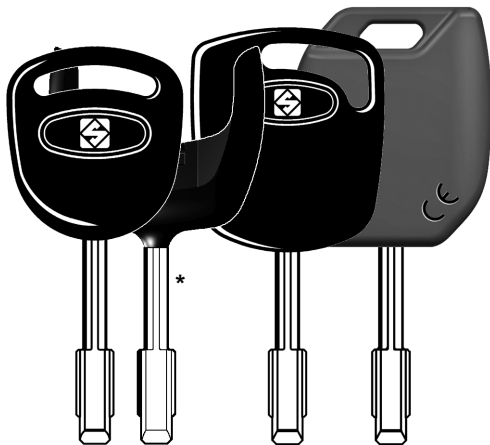

FO21P FO21AP FO21T3 FO21MH
FO21T3M
FO21T7
FO21FH FO21T17
FO21TE

TIBBE (DE) -VALEO (FR)

OPTIONAL



D723059ZB

G2/G5-Kit tools for FO21P keys
G2/G5-Set contropunta per chiavi FO21P
G2/G5-Werkzeuge für FO21P Schlüssell
G2/G5-Outils pour clés FO21P
G2/G5-Útiles para llaves FO21P
G2/G5-Contraponta para chaves FO21P

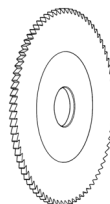
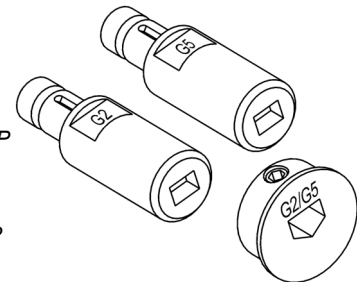

D7A3854ZB

Cutter U12W (carbide)
Fresa U12W (metallo duro)
Fräser U12W (Hartmetall)
Fraise U12W (au carbure)
Fresa U12W (metal duro)
Fresa U12W (metal duro)

PER:
FOR:

JAGUAR (GB)

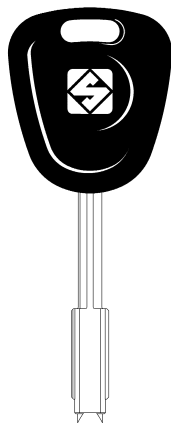

TBE1P
TBE2P
TBE1T5

TIBBE (DE) - VALEO (FR)

OPTIONAL

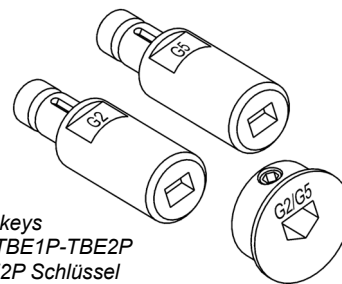

D723059ZB

G2/G5-Kit tools for TBE1P-TBE2P keys
G2/G5-Set contropunta per chiavi TBE1P-TBE2P
G2/G5-Werkzeuge für TBE1P-TBE2P Schlüssel
G2/G5-Outils pour clés TBE1P-TBE2P
G2/G5-Útiles para llaves TBE1P-TBE2P
G2/G5-Contraponta para chaves TBE1P-TBE2P

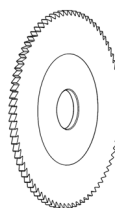

D7A3854ZB

Cutter U12W (carbide)
Fresa U12W (metal duro)
Fräser U12W (Hartmetall)
Fraise U12W (au carbure)
Fresa U12W (metal duro)
Fresa U12W (metal duro)

PER:
FOR:

LUMA (ES)

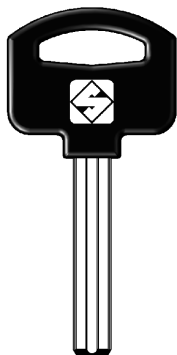

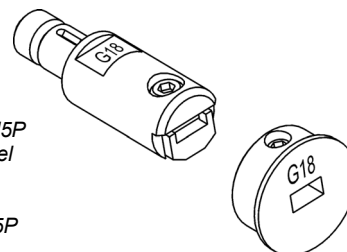

LM5P

OPTIONAL

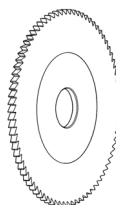

D723045ZB

G18-Kit tools for LM5P keys
G18-Set contropunta per chiavi LM5P
G18-Werkzeuge für LM5P Schlüssel
G18-Outils pour clés LM5P
G18-Útiles para llaves LM5P
G18-Contraponta para chaves LM5P



D7A3854ZB

Cutter U12W (carbide)
Fresa U12W (metal duro)
Fräser U12W (Hartmetall)
Fraise U12W (au carbure)
Fresa U12W (metal duro)
Fresa U12W (metal duro)

PER:
FOR:

ABLOY (SE)

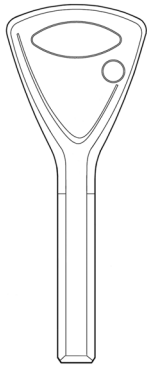

(Protec - Protec 2 Systems)

OPTIONAL

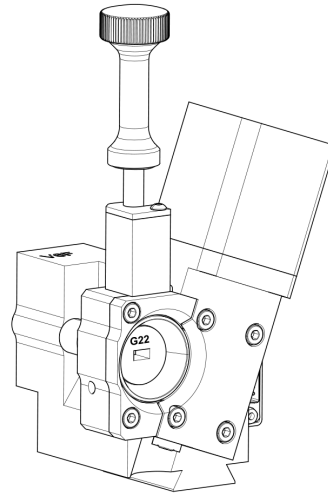

D7A7204ZB

V6F rotating clamp
Morsetto girevole V6F
V6F Spannbacke
Etau pivotant V6F
Mordaza giratoria V6F
Mordente giratorio V6F

*System protected by a password issued by Silca on receipt of authorization.
Sistema protetto da password rilasciata da Silca a fronte di autorizzazione.
Passwort geschütztes System - Freigabe des Herstellers erforderlich.
Système protégé par un password qui est émis par Silca sur autorisation.
Sistema protegido con contraseña que manda Silca previa autorización.
Sistema protegido por uma password emitida por Silca contra a autorização.*

Automatic Feeder

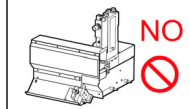

OPTIONAL

only for:

F400

F600

KIT FEEDER UNOCODE F

D7A3940ZB

*Kit Feeder Unocode F
Set Alimentatore Unocode F
Zuführungseinheit Unocode F
Kit Alimentateur Unocode F
Grupo Alimentador Unocode F
Conjunto Alimentador Unocode F*

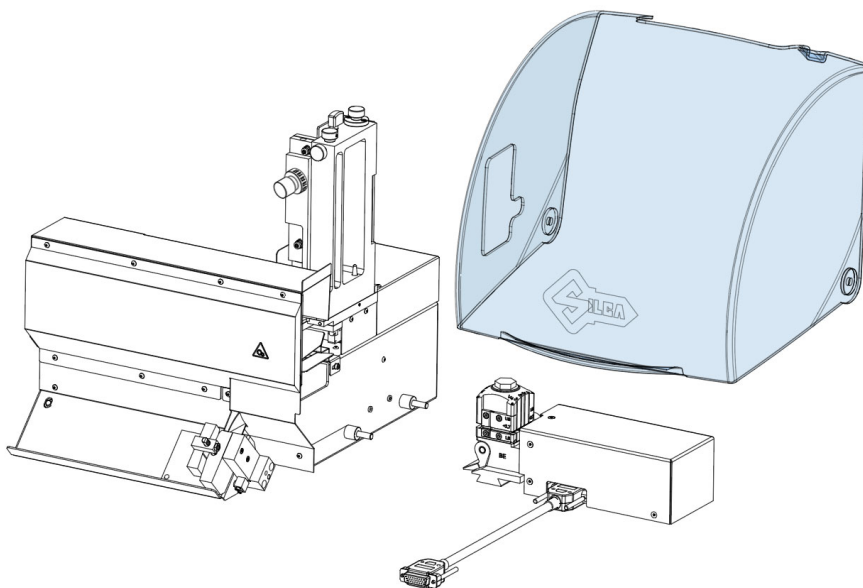

OPTIONAL

only for:

KEY FEEDER

D9A3415ZR

*Top feeder
Caricatore dall'alto
Top-Magazin
Chargeur par le haut
Cargador por arriba
Carregador do alto*

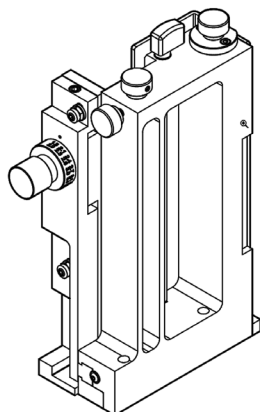

D9A4404ZR

*Keys unloading rod
Asta per scarico chiavi
Stange zum Schlüsseln ablagen
Tige pour déchargement clés
Barra descarga llaves
Vara descarga chaves*



PER:
FOR: **Silca head 843**

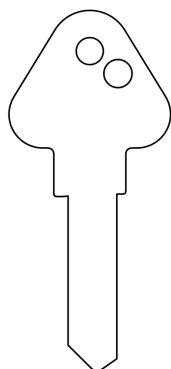

OPTIONAL

only for:

KEY FEEDER

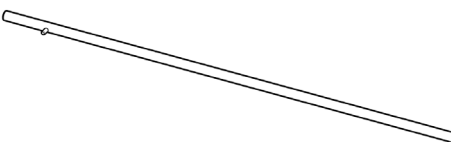
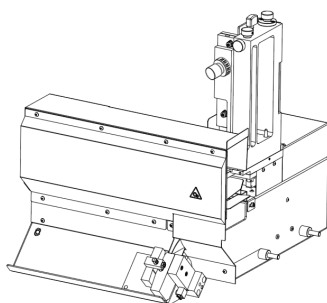

D7A5587ZB

*Rod for keys with head 843
Asta per chiavi con testa 843
Stange für Schlüssel mit Kopf 843
Tige pour clés avec tête 843
Varilla para llaves con cabeza 843
Barra de chaves com cabeça 843*

OPTIONAL

D7A3807ZB

Bracket closing the protective shield
Kit staffa chiusura carter
Schutzabdeckung zum schliessen des Splitterschutzes
Kit support fermeture écran de protection
Kit soporte cierre pantalla de protección
Kit estribo para fechar o painel de protecção

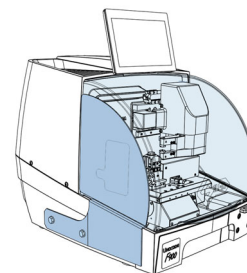
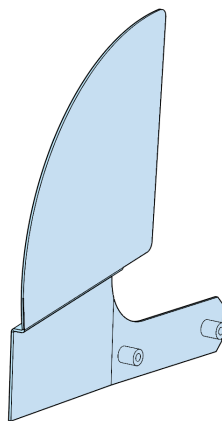

To use the key-cutting machine without the Feeder Unit (removed for maintenance, etc.).
Per utilizzare la duplicatrice senza il Gruppo Alimentatore (rimosso per manutenzione etc.).
Um die Schlüsselkopiermaschine ohne Zuführungseinheit (für Wartungsarbeiten entfernt usw.) zu verwenden.
Pour utiliser la machine sans le groupe Alimentateur (enlevé pour la maintenance, etc.).
Para utilizar la duplicadora sin el grupo alimentador (desmontado para mantenimiento, etc.).
Para utilizar a máquina duplicadora sem o Conjunto do Alimentador (removido por manutenção, etc.).